



# Roller Follower

THK General Catalog

## A Product Descriptions

<b>Features and Types</b> .....	A20-2
Features of the Roller Follower .....	A20-2
• Structure and Features .....	A20-2
Types of the Roller Follower .....	A20-3
• Types and Features .....	A20-4
• Options .....	A20-6
<b>Point of Selection</b> .....	A20-7
Nominal Life .....	A20-7
Track Load Capacity .....	A20-8
Accuracy Standards .....	A20-9
Radial Clearance .....	A20-9
<b>Dimensional Drawing, Dimensional Table</b>	
Model NAST (Separable Type) .....	A20-10
Model NAST-ZZ (Separable Type, with Side Plates) ..	A20-11
Model RNAS (Separable Type, No Inner Ring) ..	A20-12
Model NART-R (Non-separable Type) .....	A20-13
Model NURT (Double-row Cylindrical Rollers) ..	A20-14
<b>Point of Design</b> .....	A20-15
Fit .....	A20-15
Mounting Section .....	A20-15
<b>Model No.</b> .....	A20-16
• Model Number Coding .....	A20-16
<b>Precautions on Use</b> .....	A20-17

## B Support Book (Separate)

<b>Features and Types</b> .....	B20-2
Features of the Roller Follower .....	B20-2
• Structure and Features .....	B20-2
Types of the Roller Follower .....	B20-3
• Types and Features .....	B20-4
• Options .....	B20-6
<b>Point of Selection</b> .....	B20-7
Nominal Life .....	B20-7
Track Load Capacity .....	B20-9
• Example of Calculating a Track Load Capacity ...	B20-9
<b>Mounting Procedure and Maintenance</b> ..	B20-10
Installation .....	B20-10
Contamination Protection and Lubrication ..	B20-10
<b>Model No.</b> .....	B20-11
• Model Number Coding .....	B20-11
<b>Precautions on Use</b> .....	B20-12

## Features of the Roller Follower

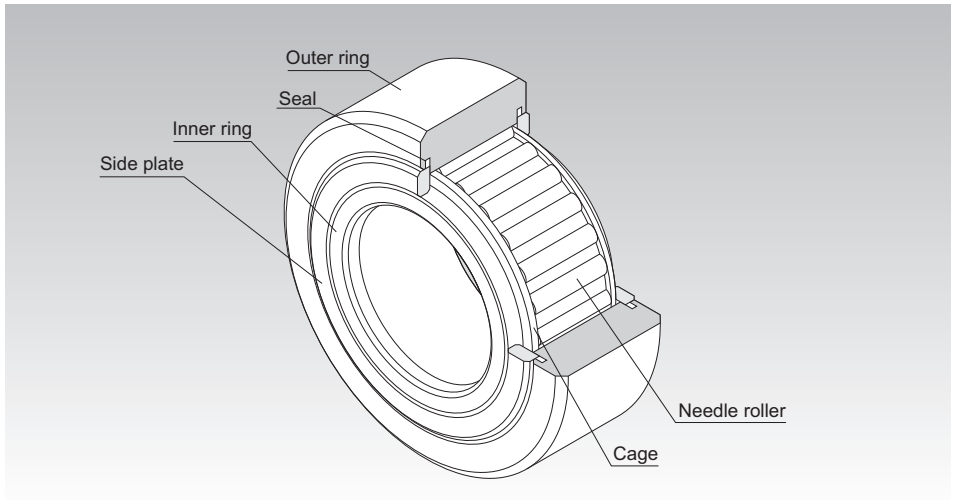

Fig.1 Structure of Roller Follower Model NAST-ZZUU

---

### Structure and Features

---

The Roller Follower is a compact and highly rigid bearing system. It contains needle bearings and is used as a guide roller for cam discs and straight motion.

Since its outer ring rotates while keeping direct contact with the mating surface, this product is thick-walled and designed to bear an impact load.

Inside the outer ring, needle rollers and a precision cage are incorporated. This prevents the product from skewing and achieves a superb rotation performance. And, as a result, the product is capable of easily withstanding high-speed rotation.

Roller Followers are divided into two types: separable type whose inner ring can be separated, and non-separable type whose inner ring cannot be separated.

There are two types of the outer ring in shape: spherical and cylindrical. The spherical outer ring easily absorbs a distortion of the shaft center when the cam follower is installed and helps lighten a biased load.

The Roller Follower is used in a wide range of applications such as cam mechanisms of automatic machines, dedicated machines as well as carrier systems, conveyors, bookbinding machines, tool changers of machining centers, pallet changers, automatic coating machines, and sliding forks of automatic warehouses.

# Types of the Roller Follower

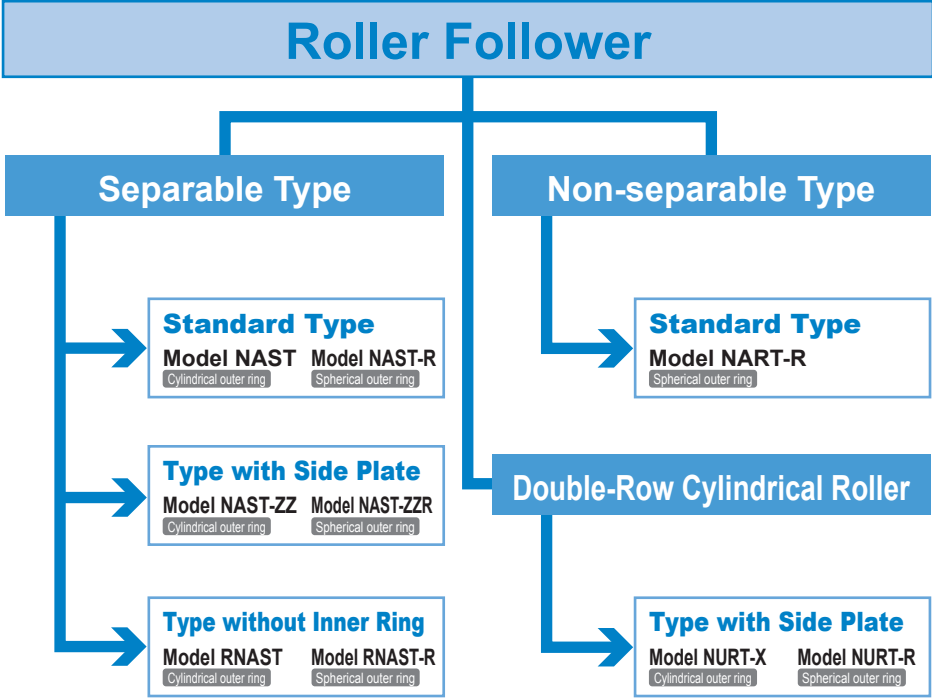

# Types of the Roller Follower

## Types and Features

### Model NAST (Separable Type)

Model NAST is a separable type of bearing system that combines a thick-wall outer ring, an inner ring and needle rollers equipped with a precision cage.

Inner diameter: 6-50mm

Specification Table⇒ [A20-10](#)

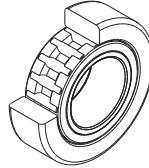

Model NAST

### Model NAST-ZZ (Separable Type, with Side Plates)

This separable type of bearing system has a labyrinth seal consisting of a pair of side plates formed on both sides of the inner ring of model NAST. (Model number of the type attached with seals is NAST-ZZUU.)

Inner diameter: 6-50mm

Specification Table⇒ [A20-11](#)

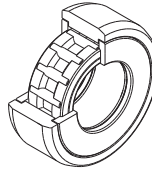

Model NAST-ZZ

### Model RNAS (Separable Type, No Inner Ring)

This model is basically the same as model NAST, but does not have an inner ring.

Inner diameter: 7-60mm

Specification Table⇒ [A20-12](#)

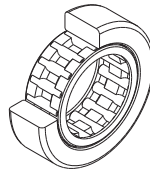

Model RNAS

## Model NART-R(Non-separable Type)

Specification Table⇒ **A**20-13

This model is a non-separable type of bearing system whose inner ring is fixed to the side plates.

Since the circumference of the outer ring is spherically ground, it helps lighten a biased load (symbol R). (Model number of the type attached with seals is NART-UUR.)

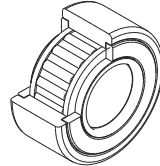

Model NART-R

Inner diameter: 5-50mm

## Model NURT (Double-row Cylindrical Rollers)

Specification Table⇒ **A**20-14

This model, which employs a double row of cylindrical rollers, can accommodate high radial loads.

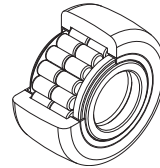

Model NURT

Inner diameter: 15-50mm

## Options

Note: Different features and options are available, depending on the model. For details, please refer to the dimension table for the product in question.

### ● Type of material

Carbon steel and stainless steel are available.

Stainless steel, which is more resistant to corrosion, is the best choice for use in clean rooms and other oil-free environments.

### ● Roller guide

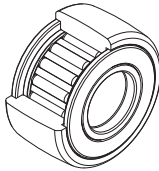

With cage (No Symbol)

The caged format, which offers optimal lubrication conditions, is best for high-speed rotation.

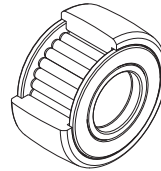

Full rollers (V)

The full-complement roller format is best for low-speed rotation and heavy loads.

Note: Please make sure to follow the lubrication schedule.

### ● With/without a seal

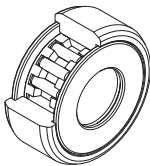

Without seal (No symbol)

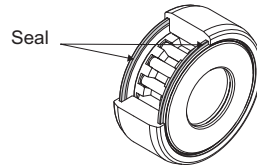

With seal (UU)

Equipped with a highly wear-resistant synthetic rubber seal to keep foreign matter out of the unit's interior.

### ● Outer ring outer surface configuration

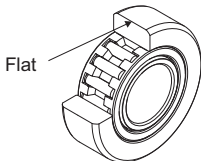

Cylindrical outer ring (No Symbol)

This model offers an expansive area of contact between rolling surfaces and is therefore ideal for heavy loads and low-rigidity rolling surfaces.

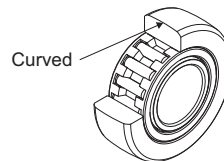

Spherical outer ring (R)

This helps alleviate the effects of an eccentric load in the event of adverse conditions around the outer ring and rolling surface.

## Nominal Life

### [Static Safety Factor]

The basic static load rating  $C_0$  refers to the static load with constant direction and magnitude, under which the calculated contact stress in the center of the contact area between the roller and the raceway under the maximum load is 4000 MPa. (If the contact stress exceeds this level, it will affect the rotation.) This value is indicated as “ $C_0$ ” in the specification tables. When a load is statically or dynamically applied, it is necessary to consider the static safety factor as shown below.

$$\frac{C_0}{P_0} = f_s$$

- $f_s$  : Static safety factor (see Table1)
- $C_0$  : Basic static load rating (kN)
- $P_0$  : Radial load (kN)

Table1 Static Safety Factor ( $f_s$ )

Load conditions	Lower limit of $f_s$
Normal load	1 to 3
Impact load	3 to 5

\* The minimum value for the static safety factor is based on the presumption of appropriate lubrication and optimal conditions for mounting and assembly. It is not possible to calculate the effect on internal loads that may be caused by improper mounting, deformation of mounting components, or the like. Please take all necessary action to ensure safety.

### [Nominal Life]

The service life of the Roller Follower is obtained from the following equation.

$$L = \left( \frac{f_r \cdot C}{f_w \cdot P_c} \right)^{\frac{10}{3}} \times 10^6$$

- $L$  : Nominal life  
(The total number of revolutions that 90% of a group of identical Roller Follower units independently operating under the same conditions can achieve without showing flaking from rolling fatigue)
- $C$  : Basic dynamic load rating\* (kN)
- $P_c$  : Radial load (kN)
- $f_r$  : Temperature factor  
(see Fig.1 on **A20-8**)
- $f_w$  : Load factor (see Table2 on **A20-8**)

\* The basic dynamic load rating (C) of the Roller Follower shows the load with interlocked direction and magnitude, under which the nominal life (L) is 1 million revolutions when a group of identical Roller Follower units independently operate. The basic dynamic load rating (C) is indicated in the corresponding specification table.

### [Calculating the Service Life Time]

When the nominal life (L) has been obtained, the service life time (L<sub>h</sub>) is obtained from the following equation.

#### ● For Linear Motion

$$L_h = \frac{D \cdot \pi \cdot L}{2 \times l_s \cdot n_1 \times 60}$$

- L<sub>h</sub> : Service life time (h)  
 L : Nominal life  
 D : Bearing outer diameter (mm)  
 l<sub>s</sub> : Stroke length (mm)  
 n<sub>1</sub> : Number of reciprocations per minute (min<sup>-1</sup>)

#### ● For Rotary Motion

$$L_h = \frac{D \cdot L}{D_1 \cdot n \times 60}$$

- D<sub>1</sub> : Outer ring contact average diameter of the cam (mm)  
 n : Rotation speed per minute of the cam (min<sup>-1</sup>)

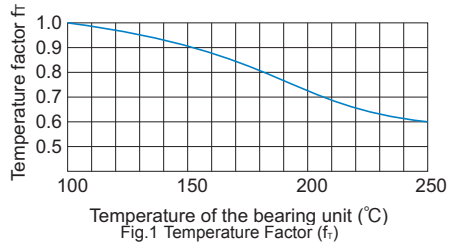

Note) The normal service temperature is 80°C or below. If the product is to be used at a higher temperature, contact THK.

Table2 Load Factor (f<sub>w</sub>)

Service condition	f <sub>w</sub>
Smooth motion without impact	1 to 1.2
Normal motion	1.2 to 1.5
Motion with severe impact	1.5 to 3

## Track Load Capacity

Track load capacity refers to the permissible load which the outer ring of the roller follower and its mating surface material can withstand given repeated use over a long period.

The track load capacity provided in the specification table, indicates the value when using a steel material with tensile strength of 1.2 kN/mm<sup>2</sup> as the mating material. Therefore, it is possible to increase the track load capacity by increasing the hardness of the material. Fig.2 shows the hardness of the mating material and the track capacity factor in relation to tensile strength. To obtain the track load capacity of each mating material, multiply the track load capacity shown in the corresponding specification table by the respective track load factor.

Note) For the mating material, we recommend using those materials with the raceway hardness of 20 HRC or higher and the tensile strength of 755 N/mm<sup>2</sup> or higher.

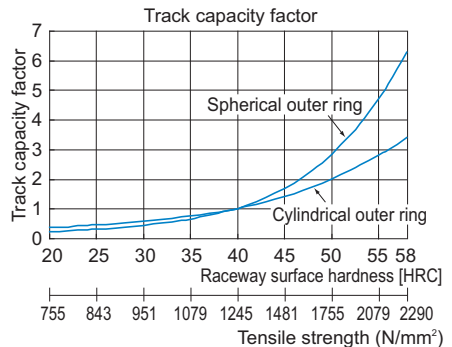

Fig.2 Track Capacity Factor



## Accuracy Standards

Roller Followers are manufactured with accuracies in accordance with the following.

- (1) Dimensional tolerance of the spherical outer ring in outer diameter D:  $\begin{matrix} 0 \\ -0.05 \end{matrix}$
- (2) Dimensional tolerance of model RNAS in inscribed bore diameter dr: F6
- (3) Dimensional tolerance of model NART and NURT in bearing width B: Table3
- (4) Accuracy of the inner ring and accuracy of the outer ring in width: Table4
- (5) Accuracy of the outer ring: Table5

Table4 Accuracy of the Inner Ring and Accuracy of the Outer Ring in Width (JIS Class 0)

Unit:  $\mu\text{m}$

Nominal dimension of the bearing inner diameter (di) (mm)	Tolerance of the bearing in outer diameter (dm) <sup>(note)</sup>	Tolerance of the inner ring (or outer ring) in width		Tolerance of the inner ring in radial runout (max)		
		Upper	Lower			
2.5	10	0	-8	0	-120	10
10	18	0	-8	0	-120	10
18	30	0	-10	0	-120	13
30	50	0	-12	0	-120	15

Note) "dm" represents the arithmetic average of the maximum and minimum diameters obtained in measuring the bearing inner diameter at two points.

Table3 Dimensional tolerance of model NART and NURT in bearing width B  
Unit:  $\mu\text{m}$

Model No.	Dimensional tolerance (h12)	
	Min.	Max.
5 to 12	0	-0.18
15 to 35	5	-0.21
40 to 50	5	-0.25

Table5 Accuracy of the Outer Ring (JIS Class 0)

Unit:  $\mu\text{m}$

Nominal dimension of the bearing outer diameter (D) (mm)		Tolerance of the bearing in outer diameter (Dm) <sup>(note)</sup>		Tolerance of the outer ring in radial runout (max)
Above	Or less	Upper	Lower	
6	18	0	-9	15
18	30	0	-9	15
30	50	0	-11	20
50	80	0	-13	25
80	120	0	-15	35

Note) "Dm" represents the arithmetic average of the maximum and minimum diameters obtained in measuring the bearing outer diameter at two points.

## Radial Clearance

The radial clearances of caged type Roller Followers are based on the values indicated in the tables below (both full-roller type and caged type of model NART share the same radial clearance).

Model NAST, NAST-ZZ Unit:  $\mu\text{m}$

Model No.	Radial clearance (with cage)	
	Min.	Max.
6	5	20
8 to 12	5	25
15 to 25	10	30
30 to 40	10	40
45 to 50	15	50

Model NURT Unit:  $\mu\text{m}$

Model No.	Radial Clearance	
	Min.	Max.
15 to 30-1	0	25
35 to 40-1	5	30
45 to 50-1	5	35

Model NART Unit:  $\mu\text{m}$

Model No.	Radial clearance (caged type and full-roller type)	
	Min.	Max.
5 to 6	5	20
8 to 12	5	25
15 to 20	10	30
25 to 40	10	40
45 to 50	15	50

# Model NAST (Separable Type)

Optional specifications		Symbol
Material	Carbon steel	No Symbol
	Stainless steel	M
Roller guide	With cage	No Symbol
Seal	Without seal	No Symbol
Outer ring shape	Cylindrical outer ring	No Symbol
	Spherical outer ring	R

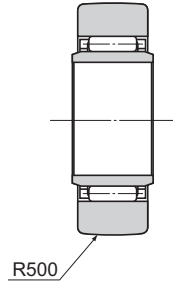
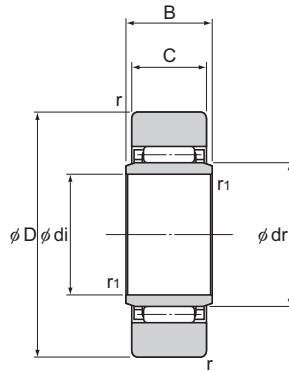

Model NAST

Model NAST-R

Unit: mm

Model No.	Main dimensions							Basic load rating		Track load capacity		Rotational speed limit* min <sup>-1</sup>	Mass g
	Inner diameter di	Inscribed bore diameter dr	Outer diameter D	B	C	r <sub>min</sub>	r <sub>1min</sub>	C kN	C <sub>0</sub> kN	Cylindrical outer ring kN	Spherical outer ring kN		
NAST 6	6	10	19	10	9.8	0.3	0.3	4.12	4.55	3.53	1.37	20000	17.8
NAST 8	8	12	24	10	9.8	0.6	0.3	5.68	5.89	4.02	1.86	17000	28
NAST 10	10	14	30	12	11.8	1	0.3	9.7	9.67	5.59	2.45	15000	50
NAST 12	12	16	32	12	11.8	1	0.3	10.4	10.9	5.98	2.74	13000	58
NAST 15	15	20	35	12	11.8	1	0.3	12.3	14.3	6.57	3.14	10000	62
NAST 17	17	22	40	16	15.8	1	0.3	17.4	20.9	10.9	3.72	9500	110
NAST 20	20	25	47	16	15.8	1	0.3	19.2	24.5	12.7	4.61	8500	155
NAST 25	25	30	52	16	15.8	1	0.3	20.7	28.4	14.1	5.29	7000	180
NAST 30	30	38	62	20	19.8	1	0.6	30.3	45.4	22.1	6.66	5500	320
NAST 35	35	42	72	20	19.8	1	0.6	32.2	50.6	25.7	8.13	5000	440
NAST 40	40	50	80	20	19.8	1.5	1	35.7	61.6	26.9	9.31	4000	530
NAST 45	45	55	85	20	19.8	1.5	1	37.1	66.4	28.5	10.1	4000	580
NAST 50	50	60	90	20	19.8	1.5	1	38.7	71.8	30.2	11	3500	635

Note) The rotation speed limit value in the table (\*) applies to models using grease lubrication. With those models using oil lubrication, up to 130% of this value is permitted.

For information on accuracy standards, please refer to **A20-9**.

## Model number coding

# NAST 25 M R

No Symbol : Cylindrical outer ring  
R : Spherical outer ring

No symbol: Carbon steel  
M : Stainless steel

# Model NAST-ZZ (Separable Type, with Side Plates)

Optional specifications		Symbol
Material	Carbon steel	No Symbol
	Stainless steel	M
Roller guide	With cage	No Symbol
Seal	Without seal	No Symbol
	With seal	UU
Outer ring shape	Cylindrical outer ring	No Symbol
	Spherical outer ring	R

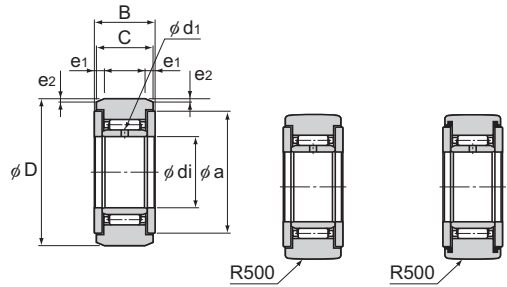

Model NAST-ZZ

Model NAST-ZZR

Model NAST-ZZUUR

Unit: mm

Model No.	Main dimensions								Basic load rating		Track load capacity		Rotational speed limit* min <sup>-1</sup>	Mass g
	Inner diameter di	Outer diameter D	B	C	a	e <sub>1</sub>	e <sub>2</sub>	Oil hole d <sub>1</sub>	C kN	C <sub>0</sub> kN	Cylindrical outer ring kN	Spherical outer ring kN		
NAST 6ZZ	6	19	14	13.8	14	2.5	0.8	1.5	4.12	4.55	3.53	1.37	20000	24.5
NAST 8ZZ	8	24	14	13.8	17.5	2.5	0.8	1.5	5.68	5.89	4.51	1.86	17000	39
NAST 10ZZ	10	30	16	15.8	23.5	2.5	0.8	2.0	9.7	9.67	6.86	2.45	15000	65
NAST 12ZZ	12	32	16	15.8	25.5	2.5	0.8	2.0	10.4	10.9	7.35	2.74	13000	75
NAST 15ZZ	15	35	16	15.8	29	2.5	0.8	2.0	12.3	14.3	8.04	3.14	10000	83
NAST 17ZZ	17	40	20	19.8	32.5	3	1	2.0	17.4	20.9	11.8	3.72	9500	135
NAST 20ZZ	20	47	20	19.8	38	3	1	2.5	19.2	24.5	13.8	4.61	8500	195
NAST 25ZZ	25	52	20	19.8	43	3	1	2.5	20.7	28.4	15.3	5.29	7000	225
NAST 30ZZ	30	62	25	24.8	50.5	4	1.2	3.0	30.3	45.4	22.1	6.66	5500	400
NAST 35ZZ	35	72	25	24.8	53.5	4	1.2	3.0	32.2	50.6	25.7	8.13	5000	550
NAST 40ZZ	40	80	26	25.8	61.5	4	1.2	3.0	35.7	61.6	30.3	9.31	4000	710
NAST 45ZZ	45	85	26	25.8	66.5	4	1.2	3.0	37.1	66.4	31.1	10.1	4000	760
NAST 50ZZ	50	90	26	25.8	76	4	1.2	3.0	38.7	71.8	34	11	3500	830

Note) The rotation speed limit value in the table (\* ) applies to models that have no seal and use grease lubrication. With those models using oil lubrication, up to 130% of this value is permitted. With those attached with seals, up to 70% of this value is permitted. For information on accuracy standards, please refer to **A20-9**.

### Model number coding

**NAST 25 M ZZ UU R**

No symbol: Carbon steel  
M : Stainless steel

No Symbol : Cylindrical outer ring  
R : Spherical outer ring

No symbol: Without seal  
UU : With seal

# Model RNAS (Separable Type, No Inner Ring)

Optional specifications		Symbol
Material	Carbon steel	No Symbol
	Stainless steel	M
Roller guide	With cage	No Symbol
Seal	Without seal	No Symbol
Outer ring shape	Cylindrical outer ring	No Symbol
	Spherical outer ring	R

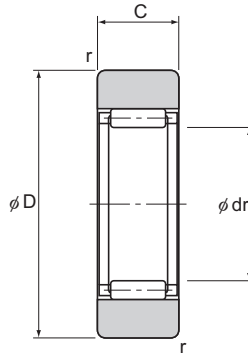

Model RNAS

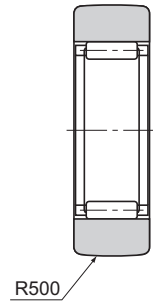

Model RNAS-R

Unit: mm

Model No.	Main dimensions				Basic load rating		Track load capacity		Rotational speed limit* min <sup>-1</sup>	Mass g
	Inscribed bore diameter dr	Outer diameter D	C	$r_{\text{min}}$	C kN	$C_0$ kN	Cylindrical outer ring kN	Spherical outer ring kN		
RNAS 5	7	16	7.8	0.3	2.74	2.39	2.35	1.08	30000	8.9
RNAS 6	10	19	9.8	0.3	4.12	4.55	3.53	1.37	20000	13.9
RNAS 8	12	24	9.8	0.6	5.68	5.89	4.02	1.86	17000	23.5
RNAS 10	14	30	11.8	1	9.7	9.67	5.59	2.45	15000	42.5
RNAS 12	16	32	11.8	1	10.4	10.9	5.98	2.74	13000	49.5
RNAS 15	20	35	11.8	1	12.3	14.3	6.57	3.14	10000	50
RNAS 17	22	40	15.8	1	17.4	20.9	10.9	3.72	9500	90
RNAS 20	25	47	15.8	1	19.2	24.5	12.7	4.61	8500	135
RNAS 25	30	52	15.8	1	20.7	28.4	14.1	5.29	7000	152
RNAS 30	38	62	19.8	1	30.3	45.4	22.1	6.66	5500	255
RNAS 35	42	72	19.8	1	32.2	50.6	25.7	8.13	5000	375
RNAS 40	50	80	19.8	1.5	35.7	61.6	26.9	9.31	4000	420
RNAS 45	55	85	19.8	1.5	37.1	66.4	28.5	10.1	4000	460
RNAS 50	60	90	19.8	1.5	38.7	71.8	30.2	11	3500	500

Note) The rotation speed limit value in the table (\*) applies to models using grease lubrication. With those models using oil lubrication, up to 130% of this value is permitted.

For information on accuracy standards, please refer to **A20-9**.

## Model number coding

# RNAS 25 M R

No symbol: Carbon steel  
M : Stainless steel  
No symbol: Cylindrical outer ring  
R : Spherical outer ring

# Model NART-R (Non-separable Type)

Optional specifications		Symbol
Material	Carbon steel	No Symbol
	Stainless steel	M
Roller guide	With cage	No Symbol
	Full rollers	V
Seal	Without seal	No Symbol
	With seal	UU
Outer ring shape	Spherical outer ring	R

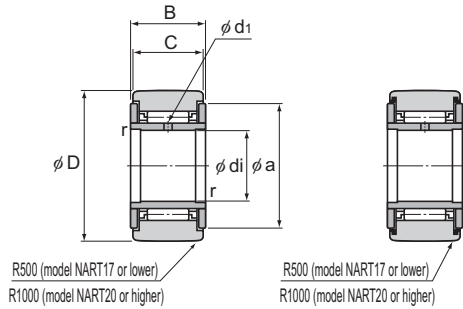

Model NART-R

Model NART-UUR

Unit: mm

Model No.	Main dimensions							Basic load rating				Track load capacity Spherical outer ring kN	Rotational speed limit*		Mass	
	Inner diameter	Outer diameter	B	C	a	r <sub>min</sub>	Oil hole d <sub>1</sub>	With cage		Full rollers			With cage	Full rollers	With cage	Full rollers
	di	D						C <sub>0</sub> kN	C <sub>0</sub> kN	C <sub>0</sub> kN	C <sub>0</sub> kN	min <sup>-1</sup>	min <sup>-1</sup>	g	g	
NART 5R	5	16	12	11	12	0.3	1.5	2.84	2.65	6.46	7.81	1.08	25000	10500	14.5	15.1
NART 6R	6	19	12	11	14	0.3	1.5	3.33	3.35	7.58	10.2	1.37	20000	8700	20.5	21.5
NART 8R	8	24	15	14	17.5	0.3	1.5	5.68	5.89	11.7	15.6	1.86	17000	7000	41.5	42.5
NART 10R	10	30	15	14	23.5	0.6	2	7.94	7.59	15.8	18.5	2.45	15000	5700	64.5	66.5
NART 12R	12	32	15	14	25.5	0.6	2	8.53	8.44	17	21	2.74	13000	5200	71	73
NART 15R	15	35	19	18	29	0.6	2	13.7	16.4	25.3	36.9	3.14	10000	4300	102	106
NART 17R	17	40	21	20	32.5	1	2	17.4	19.3	32	46.6	3.72	9500	3900	149	155
NART 20R	20	47	25	24	38	1	2.5	22.9	30.6	41.7	67.7	7.15	8000	3400	250	255
NART 25R	25	52	25	24	43	1	2.5	24.6	33.3	45.4	79.5	8.23	7000	3000	285	295
NART 30R	30	62	29	28	50.5	1	3	33.4	51.4	60	111	10.5	5500	2400	470	485
NART 35R	35	72	29	28	53.5	1	3	35.5	57.3	63.2	123	12.9	5000	2200	640	655
NART 40R	40	80	32	30	61.5	1	3	44.6	81.4	76.4	166	14.9	4000	1900	845	865
NART 45R	45	85	32	30	66.5	1	3	46.6	88.6	80.5	183	16.1	4000	1700	915	935
NART 50R	50	90	32	30	76	1	3	48.3	95.7	84.4	200	17.3	3500	1600	980	1010

Note) The rotation speed limit value in the table (\* ) applies to models that have no seal and use grease lubrication. With those models using oil lubrication, up to 130% of this value is permitted. With those attached with seals, up to 70% of this value is permitted. For information on accuracy standards, please refer to **A20-9**.

## Model number coding

**NART 25 M UU V R**

No symbol: Carbon steel  
M : Stainless steel

R : Spherical outer ring

No symbol: With cage

V : Full-roller Type

No symbol: Without seal

UU : With seal

# Model NURT (Double-row Cylindrical Rollers)

Optional specifications		Symbol
Material	Carbon steel	No Symbol
Roller guide	Full rollers	No Symbol
Seal	Without seal	No Symbol
Outer ring shape	Cylindrical outer ring	X
	Spherical outer ring	R

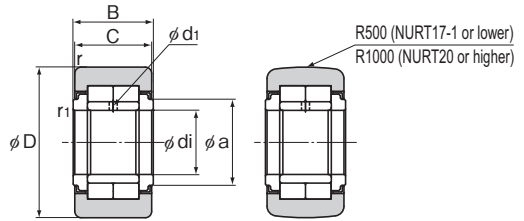

Model NURT-X

Model NURT-R

Unit: mm

Model No.	Main dimensions								Basic load rating		Maximum permissible load $F_0$ kN	Track load capacity		Rotational speed limit $\text{min}^{-1}$	Mass g
	Inner diameter $d_i$	Outer diameter D	B	C	a	$r_{\text{amin}}$	$r_{\text{amin}}$	Oil hole $d_1$	C kN	$C_0$ kN		Cylindrical outer ring kN	Spherical outer ring kN		
NURT 15	15	35	19	18	20	0.6	0.3	2	23.4	27.2	11.5	11.2	3.14	5200	100
NURT 15-1	15	42	19	18	20	0.6	0.3	2	23.4	27.2	27.2	13.3	4.06	5200	160
NURT 17	17	40	21	20	22	1	0.5	2.5	25.2	30.9	21.2	14.4	3.72	4700	150
NURT 17-1	17	47	21	20	22	1	0.5	2.5	25.2	30.9	30.9	16.9	4.72	4700	225
NURT 20	20	47	25	24	27	1	0.5	2.5	38.9	48.9	24.8	21	7.15	3800	245
NURT 20-1	20	52	25	24	27	1	0.5	2.5	38.9	48.9	42.7	23.2	8.23	3800	310
NURT 25	25	52	25	24	31	1	0.5	2.5	43	58.1	27.1	23.2	8.23	3300	285
NURT 25-1	25	62	25	24	31	1	0.5	2.5	43	58.1	58.1	27.6	10.5	3300	450
NURT 30	30	62	29	28	38	1	0.5	2.5	57.5	74.3	34.3	32.9	10.5	2800	465
NURT 30-1	30	72	29	28	38	1	0.5	2.5	57.5	74.3	74.3	38.2	12.9	2800	695
NURT 35	35	72	29	28	44	1.1	0.6	3	63.3	87.5	52.4	38.2	12.9	2300	635
NURT 35-1	35	80	29	28	44	1.1	0.6	3	63.3	87.5	87.5	42.4	14.9	2300	840
NURT 40	40	80	32	30	51	1.1	0.6	3	86.9	124	45.7	44.1	14.9	1900	820
NURT 40-1	40	90	32	30	51	1.1	0.6	3	86.9	124	96.5	49.6	17.3	1900	1130
NURT 45	45	85	32	30	55	1.1	0.6	3	91.7	137	48	46.9	16.1	1700	890
NURT 45-1	45	100	32	30	55	1.1	0.6	3	91.7	137	132	55.2	20.5	1700	1400
NURT 50	50	90	32	30	60	1.1	0.6	3	96.3	149	50.1	49.6	17.3	1500	960
NURT 50-1	50	110	32	30	60	1.1	0.6	3	96.3	149	149	60.7	23.3	1500	1690

Note) For information on accuracy standards, please refer to **A20-9**.

## Model number coding

## NURT 25 X

X: Cylindrical outer ring  
R: Spherical outer ring

## Fit

For the fitting of the Roller Follower with the shaft, we recommend the combinations indicated in Table1.

Table1 Fitting with the Shaft

No Inner Ring	Inner Ring
k5, k6	g6, h6

## Mounting Section

- The Roller Follower is designed to accommodate a radial load; subjecting it to a thrust load could result in damage to the side plate or outer ring. Care must be taken in the design and assembly of the application to avoid or minimize any thrust component.
- For models NART, NAST-ZZ, and NURT, the specification table shows the minimum permissible diameter (“a”) for the mounting section that comes into contact with the side plate. To protect the side plate, please make sure the mounting section has the appropriate diameter. If the outer ring were to move in the thrust direction, due to installation error or the like, it could come into contact with the mounting, causing wear and dust from abrasion. To avoid this, THK recommends using a mounting with the configuration and specifications shown below.

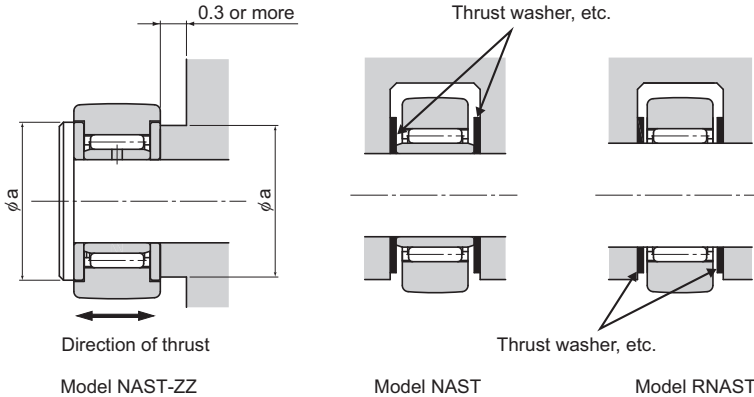

- The surface hardness of the shaft to be used with a Roller Follower without inner ring must be between 54 and 64 HRC. For the surface roughness, we recommend 0.2  $\mu\text{m}$  Ra or below.
- For the mating raceway, see “Track Load Capacity” on **A20-8**.
- If the outer ring unilaterally or unevenly contacts the mating raceway, we recommend using a type whose outer ring circumference is spherically ground.
- The side plate of model NART is press-fit onto the inner ring. If the plate is pressed under an external force, it may cause abnormal rotation. Do not use the product in the manner that the side plate is pressed.

## Model Number Coding

Model number configurations differ depending on the model features. Refer to the corresponding sample model number configuration.

### [Roller Follower]

#### ● Models NAST and RNAS

**NAST 25 M R**

No Symbol : Cylindrical outer ring  
 R : Spherical outer ring

No symbol: Carbon steel  
 M : Stainless steel

#### ● Model NAST-ZZ

**NAST 25 M ZZ UU R**

No symbol: Carbon steel  
 M : Stainless steel

No Symbol : Cylindrical outer ring  
 R : Spherical outer ring

No symbol: Without seal  
 UU : With seal

#### ● Model NART

**NART 25 M UU V R**

No symbol: Carbon steel  
 M : Stainless steel

No symbol: With cage  
 V : Full-roller Type

No symbol: Without seal  
 UU : With seal

R : Spherical outer ring

#### ● Model NURT

**NURT 25 X**

X: Cylindrical outer ring  
 R: Spherical outer ring



**[Handling]**

- (1) Do not disassemble the parts. This will result in loss of functionality.
- (2) Take care not to drop or strike the Roller Follower. Doing so may cause injury or damage. Giving an impact to it could also cause damage to its function even if the product looks intact.
- (3) When handling the product, wear protective gloves, safety shoes, etc., as necessary to ensure safety.

**[Precautions on Use]**

- (1) Do not use the product at temperature of 80°C or higher. Exposure to higher temperatures may cause the resin/rubber parts to deform/be damaged.
- (2) Prevent foreign material, such as cutting chips or coolant, from entering the product. Failure to do so may cause damage.
- (3) If foreign material such as cutting chips adheres to the product, replenish the lubricant after cleaning the product.
- (4) Roller Followers are designed for use under a radial load. Do not use the product under a thrust load.
- (5) Micro-oscillation makes it difficult for oil film to form on the raceway in contact with the rolling element, and may lead to fretting. Accordingly, use grease offering excellent fretting toughness. It is also recommended that the Cam Follower be turned once or so on a regular basis to make sure oil film is formed between the raceway and rolling element.
- (6) Insufficient rigidity or accuracy of mounting members causes the bearing load to concentrate on one point and the bearing performance will drop significantly. Accordingly, give sufficient consideration to the rigidity/accuracy of the housing and base and strength of the fixing bolts.

**[Lubrication]**

- (1) Some types of the Roller Follower do not contain grease depending on the model number. Carefully refer to **B20-10**, and if the desired model does not contain grease, apply grease to the product as necessary before using it. Lithium soap-based grease No. 2 is available as standard.
- (2) Do not mix different lubricants. In addition, replenish a lubricant also during operation as necessary. Mixing greases using the same type of thickening agent may still cause adverse interaction between the two greases if they use different additives, etc.
- (3) Prior to using the product, apply lubricant between the Roller Follower and the rolling contact surface as well.
- (4) When using the product in locations exposed to constant vibrations or in special environments such as clean rooms, vacuum and low/high temperature, use the grease appropriate for the specification/environment.
- (5) The consistency of grease changes according to the temperature. Take note that the slide resistance of the Roller Follower also changes as the consistency of grease changes.
- (6) After lubrication, the slide resistance of the Roller Follower may increase due to the agitation resistance of grease. Be sure to perform a break-in to let the grease spread fully, before operating the machine.
- (7) Even when the unit is equipped with seals, excess grease may spatter during initial use and immediately after lubrication. If necessary, wipe off any spattered grease.
- (8) The properties of grease deteriorate and its lubrication performance drops over time, so grease must be checked and added properly according to the use frequency of the machine.
- (9) The greasing interval varies depending on the use condition and service environment. Set the final lubrication interval/amount based on the actual machine.

**[Storage]**

When storing the Roller Follower, enclose it in a package designated by THK and store it in a room while avoiding high temperature, low temperature and high humidity.

After the product has been in storage for an extended period of time, lubricant inside may have deteriorated, so add new lubricant before use.

**[Disposal]**

Dispose of the product properly as industrial waste.



# Roller Follower

## THK General Catalog

### B Support Book

<b>Features and Types</b> .....	B20-2
Features of the Roller Follower .....	B20-2
• Structure and Features .....	B20-2
Types of the Roller Follower .....	B20-3
• Types and Features .....	B20-4
• Options .....	B20-6
<b>Point of Selection</b> .....	B20-7
Nominal Life .....	B20-7
Track Load Capacity .....	B20-9
• Example of Calculating a Track Load Capacity ...	B20-9
<b>Mounting Procedure and Maintenance</b> ..	B20-10
Installation .....	B20-10
Contamination Protection and Lubrication...	B20-10
<b>Model No.</b> .....	B20-11
• Model Number Coding .....	B20-11
<b>Precautions on Use</b> .....	B20-12

### A Product Descriptions (Separate)

<b>Features and Types</b> .....	A20-2
Features of the Roller Follower .....	A20-2
• Structure and Features .....	A20-2
Types of the Roller Follower .....	A20-3
• Types and Features .....	A20-4
• Options .....	A20-6
<b>Point of Selection</b> .....	A20-7
Nominal Life .....	A20-7
Track Load Capacity .....	A20-8
Accuracy Standards .....	A20-9
Radial Clearance .....	A20-9
<b>Dimensional Drawing, Dimensional Table</b>	
Model NAST (Separable Type) .....	A20-10
Model NAST-ZZ (Separable Type, with Side Plates) ..	A20-11
Model RNAS (Separable Type, No Inner Ring) ..	A20-12
Model NART-R (Non-separable Type) .....	A20-13
Model NURT (Double-row Cylindrical Rollers) ..	A20-14
<b>Point of Design</b> .....	A20-15
Fit .....	A20-15
Mounting Section .....	A20-15
<b>Model No.</b> .....	A20-16
• Model Number Coding .....	A20-16
<b>Precautions on Use</b> .....	A20-17

## Features of the Roller Follower

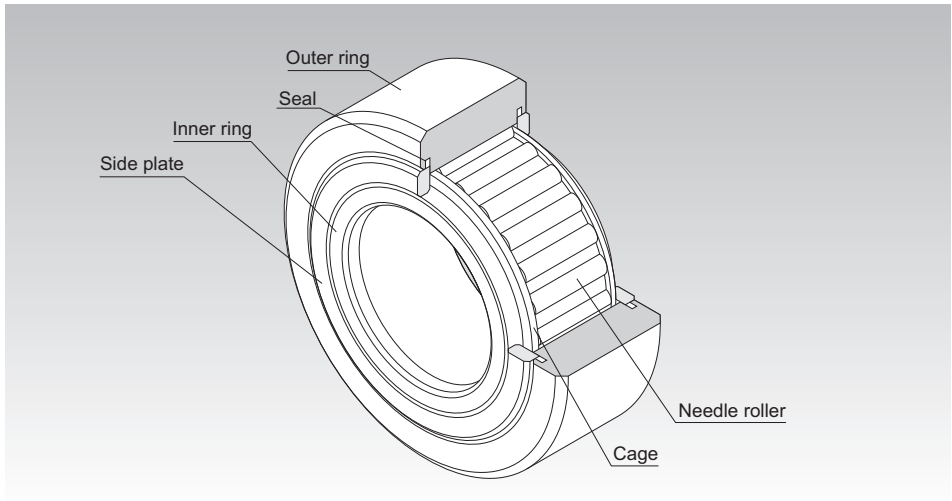

Fig.1 Structure of Roller Follower Model NAST-ZZUU

### Structure and Features

The Roller Follower is a compact and highly rigid bearing system. It contains needle bearings and is used as a guide roller for cam discs and straight motion.

Since its outer ring rotates while keeping direct contact with the mating surface, this product is thick-walled and designed to bear an impact load.

Inside the outer ring, needle rollers and a precision cage are incorporated. This prevents the product from skewing and achieves a superb rotation performance. And, as a result, the product is capable of easily withstanding high-speed rotation.

Roller Followers are divided into two types: separable type whose inner ring can be separated, and non-separable type whose inner ring cannot be separated.

There are two types of the outer ring in shape: spherical and cylindrical. The spherical outer ring easily absorbs a distortion of the shaft center when the cam follower is installed and helps lighten a biased load.

The Roller Follower is used in a wide range of applications such as cam mechanisms of automatic machines, dedicated machines as well as carrier systems, conveyors, bookbinding machines, tool changers of machining centers, pallet changers, automatic coating machines, and sliding forks of automatic warehouses.

# Types of the Roller Follower

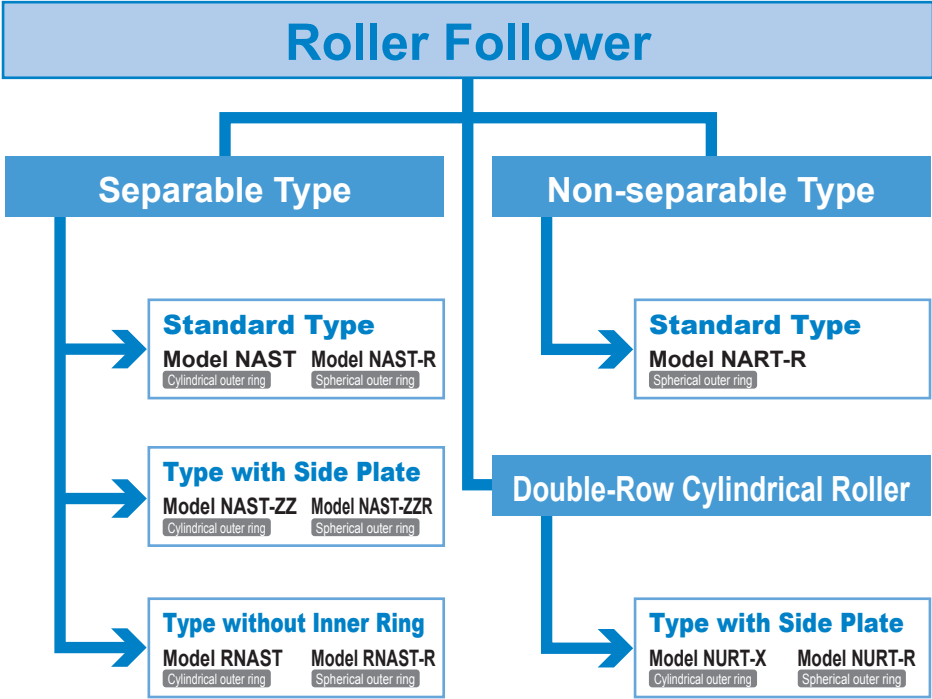

# Types of the Roller Follower

## Types and Features

### Model NAST (Separable Type)

Model NAST is a separable type of bearing system that combines a thick-wall outer ring, an inner ring and needle rollers equipped with a precision cage.

Inner diameter: 6-50mm

Specification Table⇒ [A20-10](#)

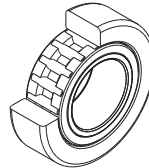

Model NAST

### Model NAST-ZZ (Separable Type, with Side Plates)

This separable type of bearing system has a labyrinth seal consisting of a pair of side plates formed on both sides of the inner ring of model NAST. (Model number of the type attached with seals is NAST-ZZUU.)

Inner diameter: 6-50mm

Specification Table⇒ [A20-11](#)

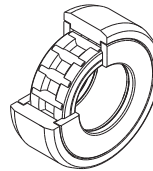

Model NAST-ZZ

### Model RNAS (Separable Type, No Inner Ring)

This model is basically the same as model NAST, but does not have an inner ring.

Inner diameter: 7-60mm

Specification Table⇒ [A20-12](#)

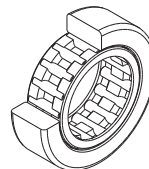

Model RNAS

## Model NART-R(Non-separable Type)

Specification Table⇒ **A** 20-13

This model is a non-separable type of bearing system whose inner ring is fixed to the side plates.

Since the circumference of the outer ring is spherically ground, it helps lighten a biased load (symbol R). (Model number of the type attached with seals is NART-UUR.)

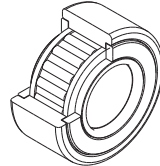

Model NART-R

Inner diameter: 5-50mm

## Model NURT (Double-row Cylindrical Rollers)

Specification Table⇒ **A** 20-14

This model, which employs a double row of cylindrical rollers, can accommodate high radial loads.

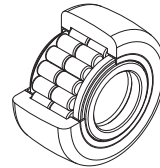

Model NURT

Inner diameter: 15-50mm

## Options

Note: Different features and options are available, depending on the model. For details, please refer to the dimension table for the product in question.

### ● Type of material

Carbon steel and stainless steel are available.

Stainless steel, which is more resistant to corrosion, is the best choice for use in clean rooms and other oil-free environments.

### ● Roller guide

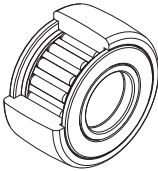

With cage (No Symbol)

The caged format, which offers optimal lubrication conditions, is best for high-speed rotation.

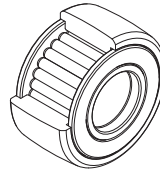

Full rollers (V)

The full-complement roller format is best for low-speed rotation and heavy loads.

Note: Please make sure to follow the lubrication schedule.

### ● With/without a seal

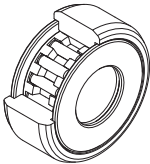

Without seal (No symbol)

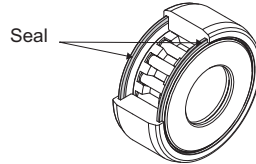

With seal (UU)

Equipped with a highly wear-resistant synthetic rubber seal to keep foreign matter out of the unit's interior.

### ● Outer ring outer surface configuration

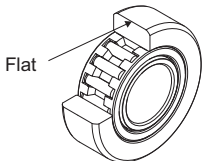

Cylindrical outer ring (No Symbol)

This model offers an expansive area of contact between rolling surfaces and is therefore ideal for heavy loads and low-rigidity rolling surfaces.

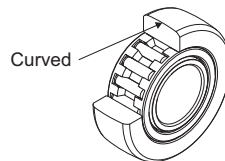

Spherical outer ring (R)

This helps alleviate the effects of an eccentric load in the event of adverse conditions around the outer ring and rolling surface.



## Nominal Life

### [Static Safety Factor]

The basic static load rating  $C_0$  refers to the static load with constant direction and magnitude, under which the calculated contact stress in the center of the contact area between the roller and the raceway under the maximum load is 4000 MPa. (If the contact stress exceeds this level, it will affect the rotation.) This value is indicated as “ $C_0$ ” in the specification tables. When a load is statically or dynamically applied, it is necessary to consider the static safety factor as shown below.

$$\frac{C_0}{P_0} = f_s$$

- $f_s$  : Static safety factor (see Table1)
- $C_0$  : Basic static load rating (kN)
- $P_0$  : Radial load (kN)

Table1 Static Safety Factor ( $f_s$ )

Load conditions	Lower limit of $f_s$
Normal load	1 to 3
Impact load	3 to 5

\* The minimum value for the static safety factor is based on the presumption of appropriate lubrication and optimal conditions for mounting and assembly. It is not possible to calculate the effect on internal loads that may be caused by improper mounting, deformation of mounting components, or the like. Please take all necessary action to ensure safety.

### [Nominal Life]

The service life of the Roller Follower is obtained from the following equation.

$$L = \left( \frac{f_r \cdot C}{f_w \cdot P_c} \right)^{\frac{10}{3}} \times 10^6$$

- $L$  : Nominal life  
(The total number of revolutions that 90% of a group of identical Roller Follower units independently operating under the same conditions can achieve without showing flaking from rolling fatigue)
- $C$  : Basic dynamic load rating\* (kN)
- $P_c$  : Radial load (kN)
- $f_r$  : Temperature factor  
(see Fig.1 on [B20-8](#))
- $f_w$  : Load factor (see Table2 on [B20-8](#))

\* The basic dynamic load rating (C) of the Roller Follower shows the load with interlocked direction and magnitude, under which the nominal life (L) is 1 million revolutions when a group of identical Roller Follower units independently operate. The basic dynamic load rating (C) is indicated in the corresponding specification table.

**[Calculating the Service Life Time]**

When the nominal life (L) has been obtained, the service life time (L<sub>h</sub>) is obtained from the following equation.

● **For Linear Motion**

$$L_h = \frac{D \cdot \pi \cdot L}{2 \times l_s \cdot n_1 \times 60}$$

- L<sub>h</sub> : Service life time (h)
- L : Nominal life (mm)
- D : Bearing outer diameter (mm)
- l<sub>s</sub> : Stroke length (mm)
- n<sub>1</sub> : Number of reciprocations per minute (min<sup>-1</sup>)

● **For Rotary Motion**

$$L_h = \frac{D \cdot L}{D_1 \cdot n \times 60}$$

- D<sub>1</sub> : Outer ring contact average diameter of the cam (mm)
- n : Rotation speed per minute of the cam (min<sup>-1</sup>)

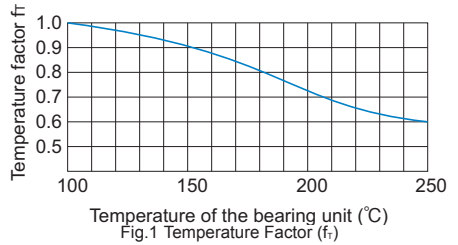

Note) The normal service temperature is 80°C or below. If the product is to be used at a higher temperature, contact THK.

Table2 Load Factor (f<sub>w</sub>)

Service condition	f <sub>w</sub>
Smooth motion without impact	1 to 1.2
Normal motion	1.2 to 1.5
Motion with severe impact	1.5 to 3

## Track Load Capacity

Track load capacity refers to the permissible load which the outer ring of the roller follower and its mating surface material can withstand given repeated use over a long period.

The track load capacity provided in the specification table, indicates the value when using a steel material with tensile strength of 1.2 kN/mm<sup>2</sup> as the mating material. Therefore, it is possible to increase the track load capacity by increasing the hardness of the material. Fig.2 shows the hardness of the mating material and the track capacity factor in relation to tensile strength. To obtain the track load capacity of each mating material, multiply the track load capacity shown in the corresponding specification table by the respective track load factor.

Note) For the mating material, we recommend using those materials with the raceway hardness of 20 HRC or higher and the tensile strength of 755 N/mm<sup>2</sup> or higher.

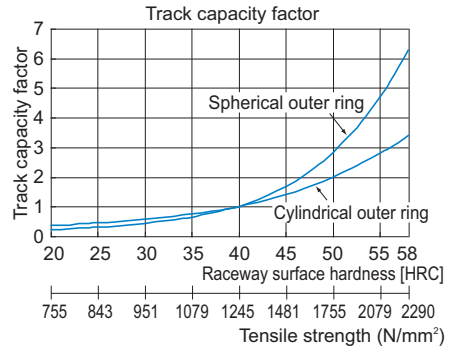

Fig.2 Track Capacity Factor

### Example of Calculating a Track Load Capacity

Obtain the track load capacity when heat-treating the mating material, which a bearing whose outer ring has a track load capacity of 5.29 kN contacts, to hardness of 50 HRC.

The track capacity factor when the hardness is 50 HRC is 2.84, as indicated in Fig.2. Therefore, the desired track load capacity is calculated as follows.

The track load capacity =  $5.29 \text{ kN} \times 2.84 = 15.0 \text{ kN}$

## Installation

Fig.1 shows examples of installing the Roller Follower.

- If the Roller Follower is to be used under a heavy load, it is necessary to install the product so that the greasing hole of the inner ring is out of the loaded area.

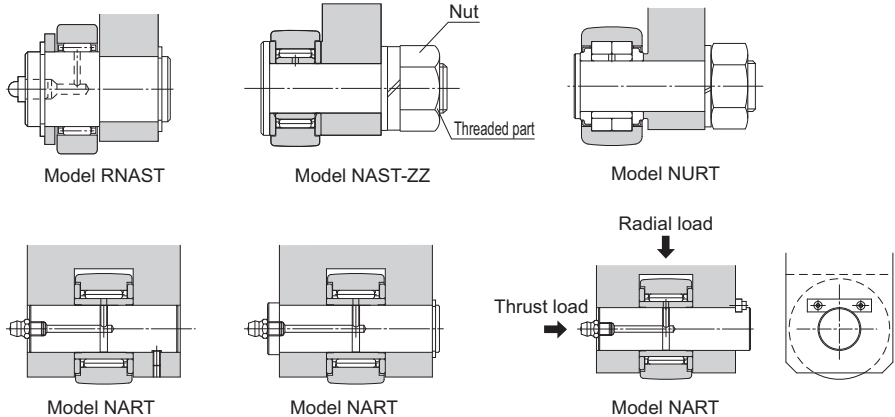

Fig.1 Examples of Installing the Roller Follower

Note) When mounting model NART, do not secure it with a nut as with model NAST-ZZ shown in the figure above. Doing so may cause the side plate to deform.

## Contamination Protection and Lubrication

Roller Followers can be equipped with highly wear-resistant synthetic rubber seals to keep foreign matter out of the unit's interior. A "UU" in the product code identifies a model equipped with seals.

Some models are pregreased during assembly while others are not. For the latter, apply a grade-2 lithium-based grease to the interior and plug the grease hole before using the product.

Model No.	Grease
NAST	Not filled with grease
RNAS	
NAST-ZZ	Filled with grease
NART	
NURT	

The lubrication interval varies depending on the operating conditions. As a guide, however, replenish grease of the same group every six months to two years for types with a cage, or every one to six months for full-roller types.

Even with types equipped with seals ("...UU"), surplus grease may seep during the initial operation period or immediately after resumption of grease replenishment. If desiring to avoid contamination of the surrounding area of the machine by grease, first perform seasoning or the like in advance, and then wipe the seeping surplus grease.

## Model Number Coding

Model number configurations differ depending on the model features. Refer to the corresponding sample model number configuration.

### [Roller Follower]

#### ● Models NAST and RNAS

**NAST 25 M R**

No symbol : Carbon steel  
 M : Stainless steel

No Symbol : Cylindrical outer ring  
 R : Spherical outer ring

#### ● Model NAST-ZZ

**NAST 25 M ZZ UU R**

No symbol: Carbon steel  
 M : Stainless steel

No symbol: Without seal  
 UU : With seal

No Symbol : Cylindrical outer ring  
 R : Spherical outer ring

#### ● Model NART

**NART 25 M UU V R**

No symbol: Carbon steel  
 M : Stainless steel

No symbol: Without seal  
 UU : With seal

No symbol: With cage  
 V : Full-roller Type

R : Spherical outer ring

#### ● Model NURT

**NURT 25 X**

X: Cylindrical outer ring  
 R: Spherical outer ring

## [Handling]

- (1) Do not disassemble the parts. This will result in loss of functionality.
- (2) Take care not to drop or strike the Roller Follower. Doing so may cause injury or damage. Giving an impact to it could also cause damage to its function even if the product looks intact.
- (3) When handling the product, wear protective gloves, safety shoes, etc., as necessary to ensure safety.

## [Precautions on Use]

- (1) Do not use the product at temperature of 80°C or higher. Exposure to higher temperatures may cause the resin/rubber parts to deform/be damaged.
- (2) Prevent foreign material, such as cutting chips or coolant, from entering the product. Failure to do so may cause damage.
- (3) If foreign material such as cutting chips adheres to the product, replenish the lubricant after cleaning the product.
- (4) Roller Followers are designed for use under a radial load. Do not use the product under a thrust load.
- (5) Micro-oscillation makes it difficult for oil film to form on the raceway in contact with the rolling element, and may lead to fretting. Accordingly, use grease offering excellent fretting toughness. It is also recommended that the Cam Follower be turned once or so on a regular basis to make sure oil film is formed between the raceway and rolling element.
- (6) Insufficient rigidity or accuracy of mounting members causes the bearing load to concentrate on one point and the bearing performance will drop significantly. Accordingly, give sufficient consideration to the rigidity/accuracy of the housing and base and strength of the fixing bolts.

## [Lubrication]

- (1) Some types of the Roller Follower do not contain grease depending on the model number. Carefully refer to **B20-10**, and if the desired model does not contain grease, apply grease to the product as necessary before using it. Lithium soap-based grease No. 2 is available as standard.
- (2) Do not mix different lubricants. In addition, replenish a lubricant also during operation as necessary. Mixing greases using the same type of thickening agent may still cause adverse interaction between the two greases if they use different additives, etc.
- (3) Prior to using the product, apply lubricant between the Roller Follower and the rolling contact surface as well.
- (4) When using the product in locations exposed to constant vibrations or in special environments such as clean rooms, vacuum and low/high temperature, use the grease appropriate for the specification/environment.
- (5) The consistency of grease changes according to the temperature. Take note that the slide resistance of the Roller Follower also changes as the consistency of grease changes.
- (6) After lubrication, the slide resistance of the Roller Follower may increase due to the agitation resistance of grease. Be sure to perform a break-in to let the grease spread fully, before operating the machine.
- (7) Even when the unit is equipped with seals, excess grease may spatter during initial use and immediately after lubrication. If necessary, wipe off any spattered grease.
- (8) The properties of grease deteriorate and its lubrication performance drops over time, so grease must be checked and added properly according to the use frequency of the machine.
- (9) The greasing interval varies depending on the use condition and service environment. Set the final lubrication interval/amount based on the actual machine.

### [Storage]

When storing the Roller Follower, enclose it in a package designated by THK and store it in a room while avoiding high temperature, low temperature and high humidity.

After the product has been in storage for an extended period of time, lubricant inside may have deteriorated, so add new lubricant before use.

### [Disposal]

Dispose of the product properly as industrial waste.

