

# SR-M1

## LM Guide High Temperature Type Model SR-M1

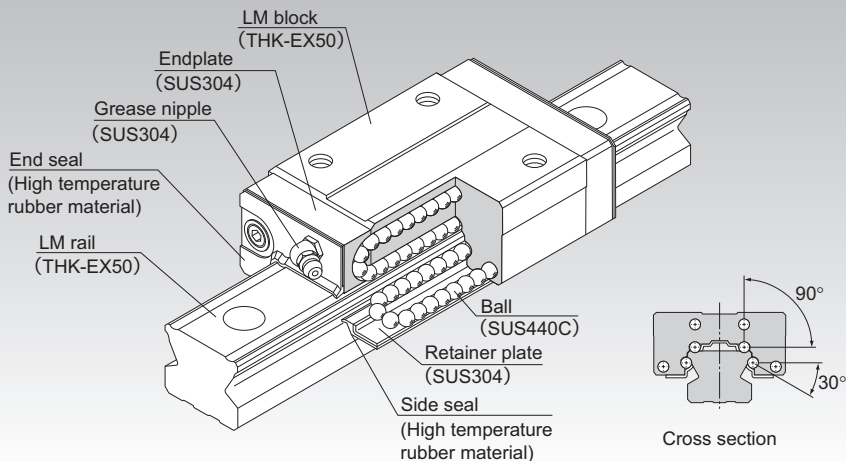

**Point of Selection** **A1-10**

**Point of Design** **A1-434**

**Options** **A1-457**

**Model No.** **A1-522**

**Precautions on Use** **A1-528**

**Accessories for Lubrication** **A24-1**

**Mounting Procedure and Maintenance** **B1-89**

Equivalent moment factor **A1-43**

Rated Loads in All Directions **A1-58**

Equivalent factor in each direction **A1-60**

Radial Clearance **A1-71**

Accuracy Standards **A1-76**

Shoulder Height of the Mounting Base and the Corner Radius **A1-443**

Permissible Error of the Mounting Surface **A1-450**

Dimensions of Each Model with an Option Attached **A1-470**

---

## Structure and Features

---

Balls roll in four rows of raceways precision-ground on an LM rail and an LM block, and endplates incorporated in the LM block allow the balls to circulate.

Since it is a compactly designed model that has a low sectional height and a ball contact structure rigid in the radial direction, this model is optimal for horizontal guide units.

High temperature type LM Guide model SR-M1 is capable of being used at service temperature up to 150°C thanks to THK's unique technologies in material, heat treatment and lubrication.

### [Maximum Service Temperature: 150°C]

Use of stainless steel in the endplates and high temperature rubber in the end seals achieves the maximum service temperature of 150°C.

### [Dimensional Stability]

Since it is dimensionally stabilized, it demonstrates superb dimensional stability after being heated or cooled (note that it shows linear expansion at high temperature).

### [Highly Corrosion Resistant]

Since the LM block, LM rail and balls use stainless steel, which is highly corrosion resistant, this model is optimal for clean room applications.

### [High Temperature Grease]

This model uses high temperature grease that shows little grease-based fluctuation in rolling resistance even if temperature changes from low to high levels.

---

## Thermal Characteristics of LM Rail and LM Block Materials

---

- Specific heat capacity: 0.481 J/(g•K)
- Thermal conductivity: 20.67 W/(m•K)
- Average coefficient of linear expansion:  $11.8 \times 10^{-6}/^{\circ}\text{C}$

## Types and Features

### Model SR-M1W

With this type, the LM block has a smaller width (W) and tapped holes.

Specification Table⇒[A1-354](#)

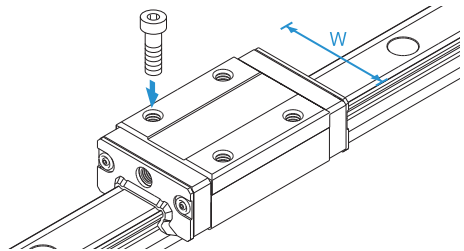

### Model SR-M1V

A space-saving type whose LM block has the same cross-sectional shape as model SR-M1W, but has a smaller overall LM block length (L).

Specification Table⇒[A1-354](#)

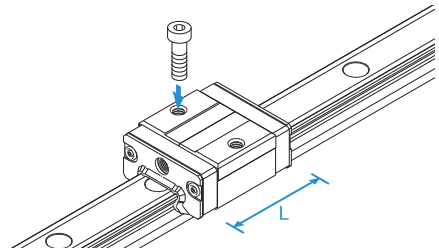

### Model SR-M1TB

The LM block has the same height as model SR-M1W and can be mounted from the bottom.

Specification Table⇒[A1-356](#)

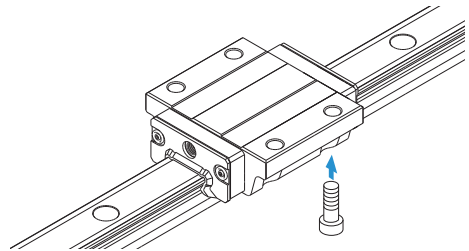

### Model SR-M1SB

A space-saving type whose LM block has the same sectional shape as model SR-M1TB, but has a smaller overall LM block length (L).

Specification Table⇒[A1-356](#)

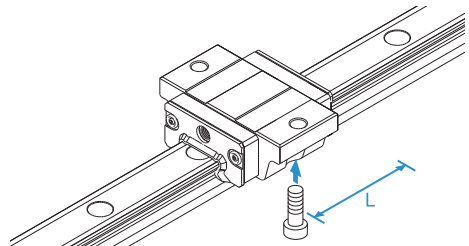

---

## Service Life

---

When using this product in temperatures higher than 100°C, always multiply the basic dynamic load rating by the temperature coefficient when calculating the rated service life. See **A1-64** for details.

## Models SR-M1W and SR-M1V

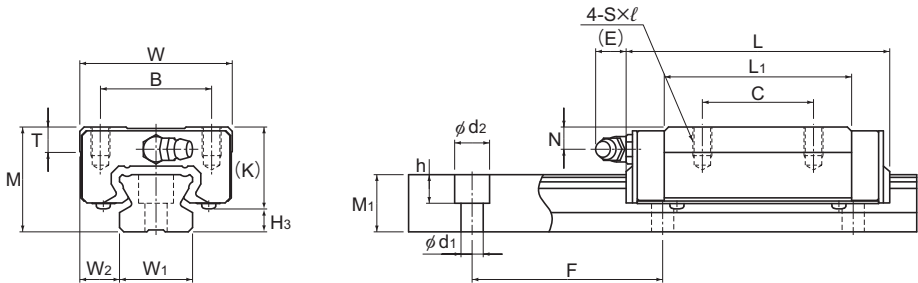

Model SR-M1W

Model No.	Outer dimensions			LM block dimensions									Grease nipple	H <sub>3</sub>
	Height	Width	Length	B	C	S × l	L <sub>1</sub>	T	K	N	E			
	M	W	L											
SR 15M1V SR 15M1W	24	34	40.4 57	26	— 26	M4 × 7	22.9 39.5	6	19.5	6	5.5	PB1021B	4.5	
SR 20M1V SR 20M1W	28	42	47.3 66.2	32	— 32	M5 × 8	27.8 46.7	7.5	22	6	12	B-M6F	6	
SR 25M1V SR 25M1W	33	48	59.2 83	35	— 35	M6 × 9	35.2 59	8	26	7	12	B-M6F	7	
SR 30M1V SR 30M1W	42	60	67.9 96.8	40	— 40	M8 × 12	40.4 69.3	9	32.5	8	12	B-M6F	9.5	
SR 35M1V SR 35M1W	48	70	77.6 111	50	— 50	M8 × 12	45.7 79	13	36.5	8.5	12	B-M6F	11.5	

### Model number coding

**SR30 M1 W 2 UU C0 +1160L Y P T - II**

Model number

Type of LM block

Contamination protection accessory symbol (\*1)

LM rail length (in mm)

Applied to only 15 and 25

Symbol for LM rail jointed use

Symbol for No. of rails used on the same plane (\*4)

Symbol for high temperature type LM Guide

No. of LM blocks used on the same rail

Radial clearance symbol (\*2)  
Normal (No symbol)  
Light preload (C1)  
Medium preload (C0)

Accuracy symbol (\*3)

Normal grade (No Symbol)/High accuracy grade (H)  
Precision grade (P)/Super precision grade (SP)  
Ultra precision grade (UP)

(\*1) See contamination protection accessory on **A1-494**. (\*2) See **A1-71**. (\*3) See **A1-76**. (\*4) See **A1-13**.

Note) This model number indicates that a single-rail unit constitutes one set. (i.e., required number of sets when 2 rails are used in parallel is 2 at a minimum.)

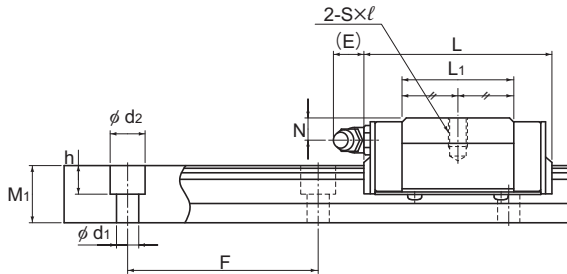

Model SR-M1V

Unit: mm

	LM rail dimensions					Basic load rating		Static permissible moment kN-m*					Mass	
	Width	Height	Pitch	Length*	C	C <sub>0</sub>	M <sub>a</sub>		M <sub>b</sub>		M <sub>c</sub>	LM block	LM rail	
	W <sub>1</sub> ±0.05	W <sub>2</sub>	M <sub>1</sub>				F	d <sub>1</sub> × d <sub>2</sub> × h	Max	kN	kN	1 block	Double blocks	1 block
15	9.5	12.5	60	3.5 × 6 × 4.5	1240	9.1 13.8	11.7 20.5	0.0344 0.0984	0.234 0.551	0.0215 0.0604	0.149 0.343	0.0694 0.122	0.12 0.2	1.2
20	11	15.5	60	6 × 9.5 × 8.5	1500	13.4 19.2	17.2 28.6	0.064 0.167	0.396 0.887	0.0397 0.102	0.25 0.55	0.135 0.224	0.2 0.3	2.1
23	12.5	18	60	7 × 11 × 9	1500	21.6 30.9	26.8 44.7	0.125 0.326	0.773 1.74	0.0774 0.2	0.488 1.08	0.245 0.408	0.3 0.4	2.7
28	16	23	80	7 × 11 × 9	1500	29.5 45.6	34.4 64.4	0.173 0.564	1.15 2.92	0.108 0.346	0.735 1.8	0.376 0.703	0.5 0.8	4.3
34	18	27.5	80	9 × 14 × 12	1500	40.9 60.4	46.7 81.8	0.275 0.785	1.79 4.27	0.171 0.482	1.14 2.65	0.615 1.08	0.8 1.2	6.4

Note1) The maximum length under "Length\*" indicates the standard maximum length of an LM rail. (See **A1-358**.)

Static permissible moment\*: 1 block: static permissible moment value with 1 LM block

Double blocks: static permissible moment value with 2 blocks closely contacting with each other

Note2) For models SR15 and 25, two types of rails with different mounting hole dimensions are offered (see Table1).

When, replacing this model with model SSR, pay attention to the mounting hole dimension of the LM rail. Contact THK for details.

Table1 The dimension of the rail mounting hole

Model No.	Standard rail	Semi-Standard rail
SR 15	For M3 (No symbol)	For M4 (Symbol Y)
SR 25	For M6 (Symbol Y)	For M5 (No symbol)

## Models SR-M1TB and SR-M1SB

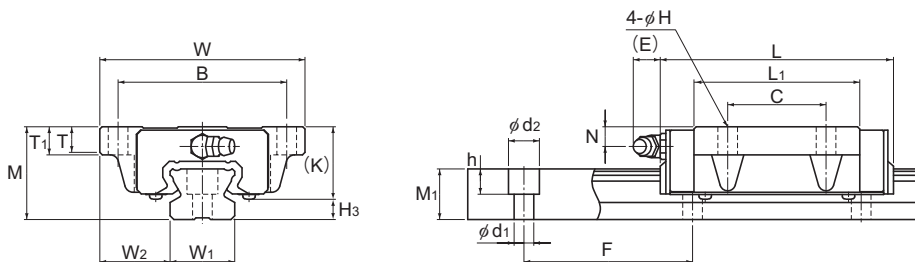

Model SR-M1TB

Model No.	Outer dimensions			LM block dimensions										Grease nipple	H <sub>3</sub>
	Height	Width	Length	B	C	H	L <sub>1</sub>	T	T <sub>1</sub>	K	N	E			
	M	W	L	B	C	H	L <sub>1</sub>	T	T <sub>1</sub>	K	N	E			
SR 15M1SB SR 15M1TB	24	52	40.4 57	41	— 26	4.5	22.9 39.5	6.1	7	19.5	6	5.5	PB1021B	4.5	
SR 20M1SB SR 20M1TB	28	59	47.3 66.2	49	— 32	5.5	27.8 46.7	8	9	22	6	12	B-M6F	6	
SR 25M1SB SR 25M1TB	33	73	59.2 83	60	— 35	7	35.2 59	9	10	26	7	12	B-M6F	7	
SR 30M1SB SR 30M1TB	42	90	67.9 96.8	72	— 40	9	40.4 69.3	8.7	10	32.5	8	12	B-M6F	9.5	
SR 35M1SB SR 35M1TB	48	100	77.6 111	82	— 50	9	45.7 79	11.2	13	36.5	8.5	12	B-M6F	11.5	

### Model number coding

**SR30 M1 W 2 UU C0 +1000L Y P T - II**

Model number

Type of LM block

Contamination protection accessory symbol (\*1)

LM rail length (in mm)

Applied to only 15 and 25

Symbol for LM rail jointed use

Symbol for No. of rails used on the same plane (\*4)

Symbol for high temperature type LM Guide

No. of LM blocks used on the same rail

Radial clearance symbol (\*2)  
Normal (No symbol)  
Light preload (C1)  
Medium preload (C0)

Accuracy symbol (\*3)

Normal grade (No Symbol)/High accuracy grade (H)  
Precision grade (P)/Super precision grade (SP)  
Ultra precision grade (UP)(\*1) See contamination protection accessory on [A1-494](#). (\*2) See [A1-71](#). (\*3) See [A1-76](#). (\*4) See [A1-13](#).

Note) This model number indicates that a single-rail unit constitutes one set. (i.e., required number of sets when 2 rails are used in parallel is 2 at a minimum.)

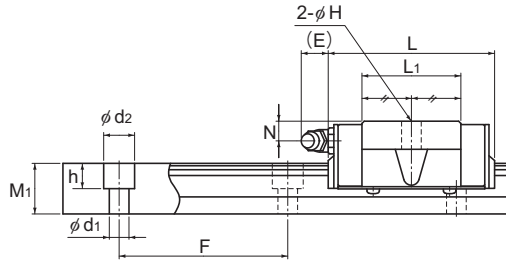

Model SR-M1SB

Unit: mm

	LM rail dimensions						Basic load rating		Static permissible moment kN-m*					Mass	
	Width	Height	Pitch		Length*	C	C <sub>0</sub>	M <sub>A</sub>		M <sub>B</sub>		M <sub>C</sub>	LM block	LM rail	
	W <sub>1</sub> ±0.05	W <sub>2</sub>	M <sub>1</sub>	F	d <sub>1</sub> ×d <sub>2</sub> ×h	Max	kN	kN	1 block	Double blocks	1 block	Double blocks	1 block	kg	kg/m
	15	18.5	12.5	60	3.5×6×4.5	1240	9.1 13.8	11.7 20.5	0.0344 0.0984	0.234 0.551	0.0215 0.0604	0.149 0.343	0.0694 0.122	0.12 0.2	1.2
	20	19.5	15.5	60	6×9.5×8.5	1500	13.4 19.2	17.2 28.6	0.064 0.167	0.396 0.887	0.0397 0.102	0.25 0.55	0.135 0.224	0.2 0.3	2.1
	23	25	18	60	7×11×9	1500	21.6 30.9	26.8 44.7	0.125 0.326	0.773 1.74	0.0774 0.2	0.488 1.08	0.245 0.408	0.3 0.4	2.7
	28	31	23	80	7×11×9	1500	29.5 45.6	34.4 64.4	0.173 0.564	1.15 2.92	0.108 0.346	0.735 1.8	0.376 0.703	0.5 0.8	4.3
	34	33	27.5	80	9×14×12	1500	40.9 60.4	46.7 81.8	0.275 0.785	1.79 4.27	0.171 0.482	1.14 2.65	0.615 1.08	0.8 1.2	6.4

Note1) The maximum length under "Length\*" indicates the standard maximum length of an LM rail. (See **A1-358**.)

Static permissible moment\*: 1 block: static permissible moment value with 1 LM block

Double blocks: static permissible moment value with 2 blocks closely contacting with each other

Note2) For models SR15 and 25, two types of rails with different mounting hole dimensions are offered (see Table1).

When, replacing this model with model SSR, pay attention to the mounting hole dimension of the LM rail. Contact THK for details.

Table1 The dimension of the rail mounting hole

Model No.	Standard rail	Semi-Standard rail
SR 15	For M3 (No symbol)	For M4 (Symbol Y)
SR 25	For M6 (Symbol Y)	For M5 (No symbol)



## Standard Length and Maximum Length of the LM Rail

Table1 shows the standard lengths and the maximum lengths of model SR-M1 variations. If the maximum length of the desired LM rail exceeds them, jointed rails will be used. Contact THK for details.

For the G dimension when a special length is required, we recommend selecting the corresponding G value from the table. The longer the G dimension is, the less stable the G area may become after installation, thus causing an adverse impact to accuracy.

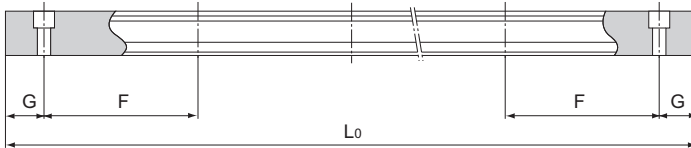

Table1 Standard Length and Maximum Length of the LM Rail for Model SR-M1

Unit: mm

Model No.	SR 15M1	SR 20M1	SR 25M1	SR 30M1	SR 35M1
LM rail standard length ( $L_0$ )	160	220	220	280	280
	220	280	280	360	360
	280	340	340	440	440
	340	400	400	520	520
	400	460	460	600	600
	460	520	520	680	680
	520	580	580	760	760
	580	640	640	840	840
	640	700	700	920	920
	700	760	760	1000	1000
	760	820	820	1080	1080
	820	940	940	1160	1160
	940	1000	1000	1240	1240
	1000	1060	1060	1320	1320
	1060	1120	1120	1400	1400
	1120	1180	1240	1480	1480
1180	1240	1300			
1240	1300	1360			
	1360	1420			
	1420	1480			
Standard pitch F	60	60	60	80	80
G	20	20	20	20	20
Max length	1240	1500	1500	1500	1500

Note1) The maximum length varies with accuracy grades. Contact THK for details.

Note2) If jointed rails are not allowed and a greater length than the maximum values above is required, contact THK.