

HSR-M2

LM Guide High Corrosion Resistance Type Model HSR-M2

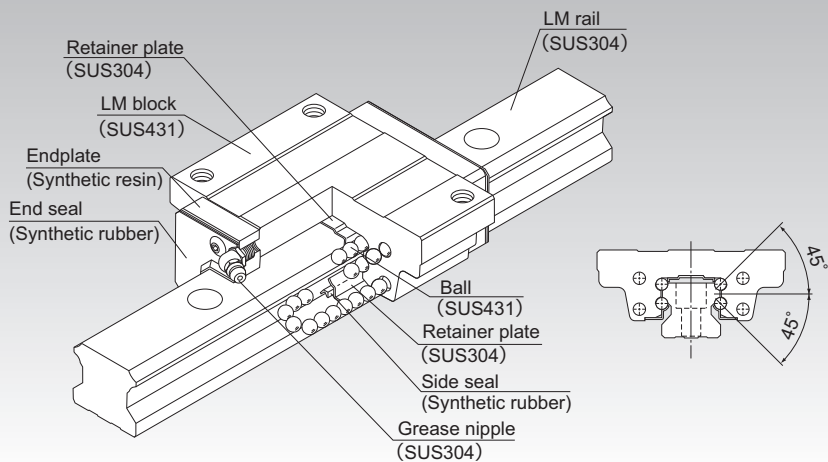

Point of Selection **A1-10**

Point of Design **A1-434**

Options **A1-457**

Model No. **A1-522**

Precautions on Use **A1-528**

Accessories for Lubrication **A24-1**

Mounting Procedure and Maintenance **B1-89**

Equivalent moment factor **A1-43**

Rated Loads in All Directions **A1-58**

Equivalent factor in each direction **A1-60**

Radial Clearance **A1-72**

Accuracy Standards **A1-76**

Shoulder Height of the Mounting Base and the Corner Radius **A1-445**

Permissible Error of the Mounting Surface **A1-450**

Dimensions of Each Model with an Option Attached **A1-470**

Structure and Features

Balls roll in four rows of raceways precision-ground on an LM rail and an LM block, and endplates incorporated in the LM block allow the balls to circulate.

Each row of balls is placed at a contact angle of 45° so that the rated loads applied to the LM block are uniform in the four directions (radial, reverse radial and lateral directions), enabling the LM Guide to be used in all orientations.

The LM rail, LM block and balls are made of highly corrosion resistant stainless steel and the other metal parts are made of stainless steel, allowing superb corrosion resistance to be achieved. As a result, the need for surface treatment is eliminated.

Types and Features

Model HSR-M2A

The flange of its LM block has tapped holes.

Specification Table⇒ **A1-372**

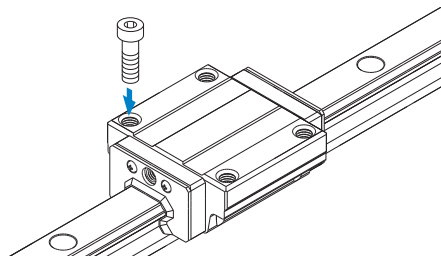

Model HSR-M2A

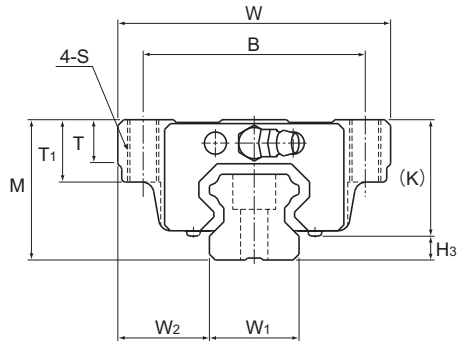

Model No.	Outer dimensions			LM block dimensions										Grease nipple	H ₃
	Height	Width	Length	B	C	S	L ₁	T	T ₁	K	N	E			
	M	W	L												
HSR 15M2A	24	47	56.6	38	30	M5	38.8	6.5	11	19.3	4.3	5.5	PB1021B	4.7	
HSR 20M2A	30	63	74	53	40	M6	50.8	9.5	10	26	5	12	B-M6F	4	
HSR 25M2A	36	70	83.1	57	45	M8	59.5	11	16	30.5	6	12	B-M6F	5.5	

Note) For the high corrosion resistance type LM Guide, a stainless steel end plate is optionally available. (symbol···I)

Model number coding

HSR20M2 A 2 UU C1 I +820L P T -II

Model number
(high corrosion
resistance type
LM Guide)

Type of
LM block

No. of LM blocks
used on the same rail

Contamination
protection
accessory
symbol (*1)

Radial clearance symbol (*2)
Normal (No symbol)
Light preload (C1)

End plate is
made of
stainless steel

LM rail length
(in mm)

Accuracy symbol (*3)

Normal grade (No Symbol)/High accuracy grade (H)
Precision grade (P)/Super precision grade (SP)
Ultra precision grade (UP)

Symbol
for LM rail
jointed use

Symbol for
No. of rails used
on the same plane (*4)

(*1) See contamination protection accessory on **A1-494**. (*2) See **A1-72**. (*3) See **A1-76**. (*4) See **A1-13**.

Note) This model number indicates that a single-rail unit constitutes one set. (i.e., required number of sets when 2 rails are used in parallel is 2 at a minimum.)

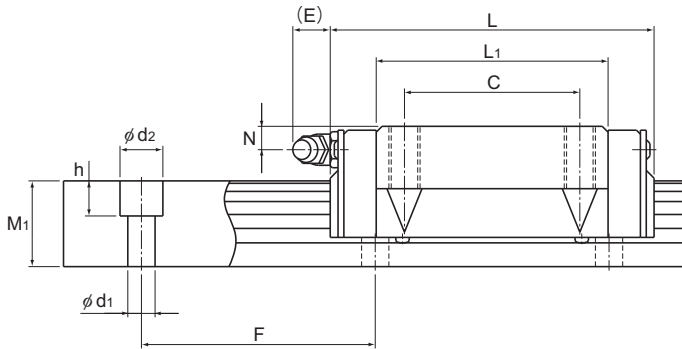

Unit: mm

LM rail dimensions						Basic load rating		Static permissible moment N·m*						Mass	
Width		Height	Pitch		Length*	C	C ₀	M _A		M _B		M _C	LM block	LM rail	
W ₁ ±0.05	W ₂	M ₁	F	d ₁ × d ₂ × h	Max	kN	kN	1 block	Double blocks	1 block	Double blocks	1 block	kg	kg/m	
15	16	15	60	4.5 × 7.5 × 5.3	1000	2.33	2.03	12.3	70.3	12.3	70.3	10.8	0.2	1.5	
20	21.5	18	60	6 × 9.5 × 8.5	1000	3.86	3.57	29	160	29	160	26.5	0.35	2.3	
23	23.5	22	60	7 × 11 × 9	1000	5.57	5.16	46.9	261	46.9	261	45.1	0.59	3.3	

Note) The maximum length under "Length*" indicates the standard maximum length of an LM rail. (See **A1-374**.)

The basic load rating of the high corrosion resistance type LM Guide is smaller than ordinary stainless steel LM Guides.

Static permissible moment*: 1 block: static permissible moment value with 1 LM block

Double blocks: static permissible moment value with 2 blocks closely contacting with each other

Standard Length and Maximum Length of the LM Rail

Table1 shows the standard lengths and the maximum lengths of model HSR-M2 variations. If the maximum length of the desired LM rail exceeds them, jointed rails will be used. Contact THK for details.

For the G dimension when a special length is required, we recommend selecting the corresponding G value from the table. The longer the G dimension is, the less stable the G area may become after installation, thus causing an adverse impact to accuracy.

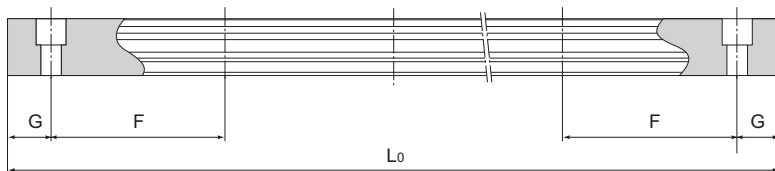

Table1 Standard Length and Maximum Length of the LM Rail for Model HSR-M2

Unit: mm

Model No.	HSR 15M2	HSR 20M2	HSR 25M2
LM rail standard length (L_0)	160	280	280
	280	460	460
	460	640	640
	640	820	820
			1000
Standard pitch F	60	60	60
G	20	20	20
Max length	1000	1000	1000

Note1) The maximum length varies with accuracy grades. Contact THK for details.

Note2) If jointed rails are not allowed and a greater length than the maximum values above is required, contact THK.